

Specifications

COMMERCIAL SIZES	11,00 x 4,00 x 1,50m
COVER PIT	Integrated, 90 cm
WATER LEVEL	1,47 m
WEIGHT	1250 kg
WATER VOLUME	50 m³

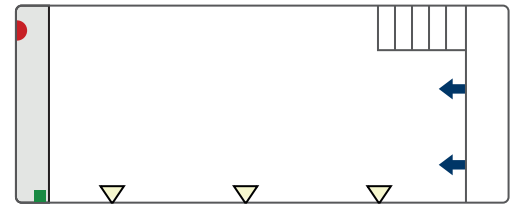

◁ Standard lights (can be placed on opposite side)
 ◐ Drain ← Injector ■ Suction connection

External (internal) dimensions / in cm – tolerance ± 2%

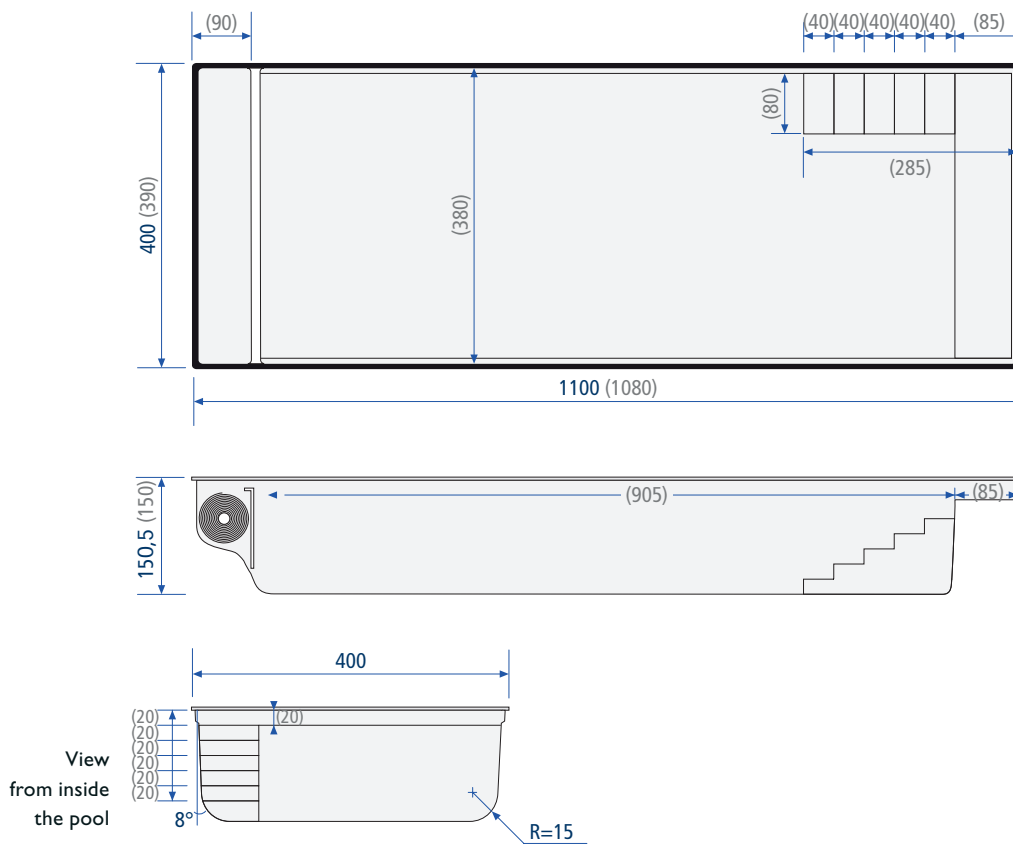

Digging sizes / in cm – tolerance ± 2%

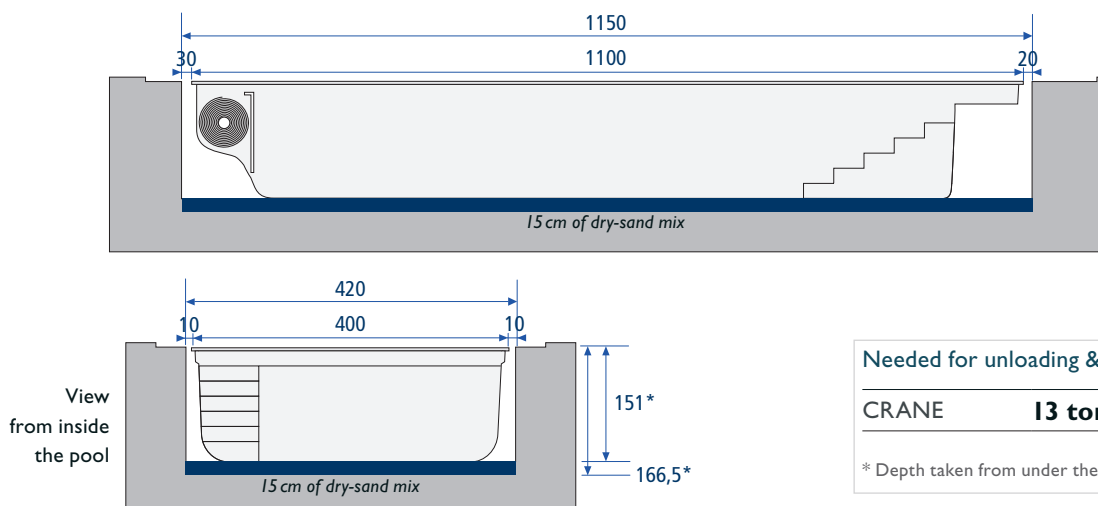

Needed for unloading & placing the pool
CRANE 13 tons
 * Depth taken from under the coping stone

Note : The digging sizes do not take into account the necessary space for the coping stones.