

Commercial sizes	8,55 x 4,00 x 1,50m
Cover pit	Integrated, 70 cm
Water level	1,45 m
Weight incl. cover system	1 050 kg
Water volume	41m³
Crane ¹	13 tons

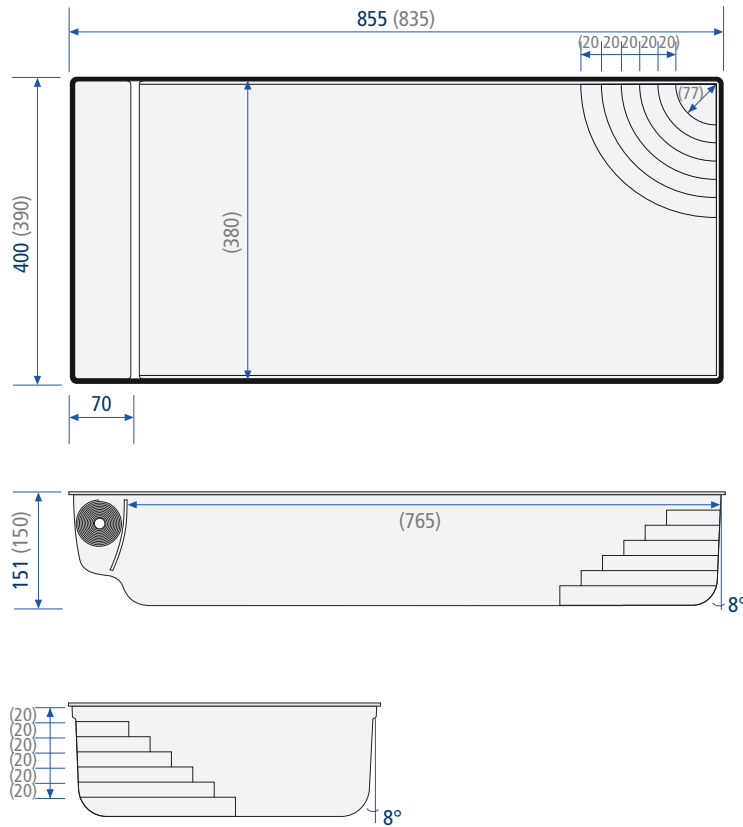

- ▼ **Standard lights**
can be placed on opposite side
- ☼ **Drain**
- ⊙ **Suction connection**
- Counter-current system (optional)⁴
- ↔ **Inlet**
Optional
2 additional injectors

External (internal) dimensions in cm – tolerance ± 2%



Digging sizes in cm – tolerance ± 2%

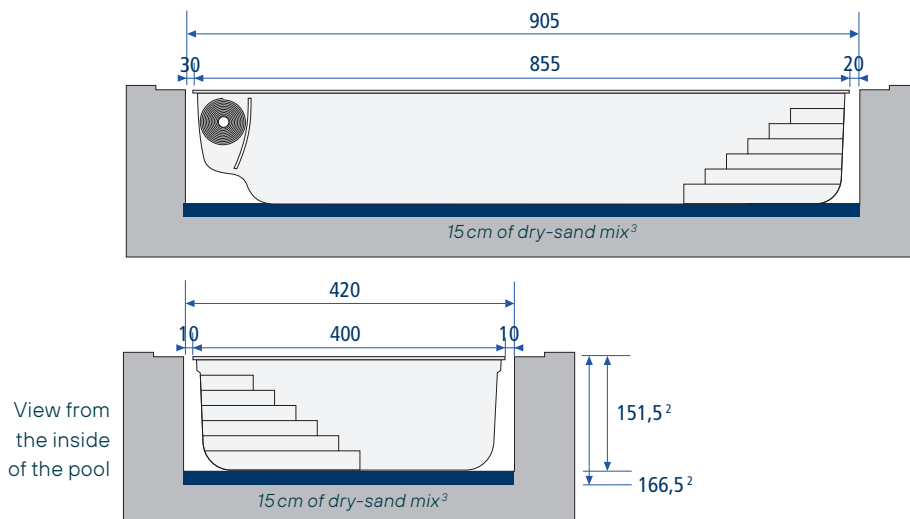

Note: the digging sizes do not take into account the necessary space for the coping stones.

¹ Needed for unloading & placing the pool. ² Depth taken from under the coping stone. ³ Mix of sand and cement, at a ratio of 250 kg per ton.

⁴ If combined with a counter current system, the position of inlets(s) may differ.