

Commercial sizes	5,5 x 2,5 x 1,40m
Cover pit	Covrex Integrated, WaluDeck mobile or bar safety cover
Water level	1,35 m
Weight incl. cover system	500 kg
Water volume	18 m³
Crane ¹	13 tonnes

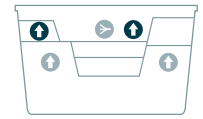
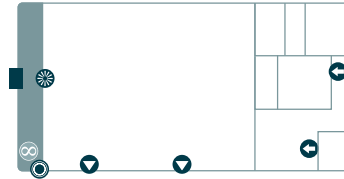

- Standard lights** can be placed on opposite side
- Drain**
- Suction connection**
- Option **WITHOUT** integrated cover 1x skimmer
- Counter-current system (optional) ⁴
- Inlet**
- 2 additional inlets (optional)
- Additional circulation (optional)

^{*} Optional: **1.** integrated Covrex® cover: 1x high level skimmer in the cover pit
^{2.} WaluDeck cover (not) motorised: 1x traditional skimmer - **3.** bar safety cover: 1x traditional skimmer

External (Internal) dimensions in cm – tolerance ± 2%

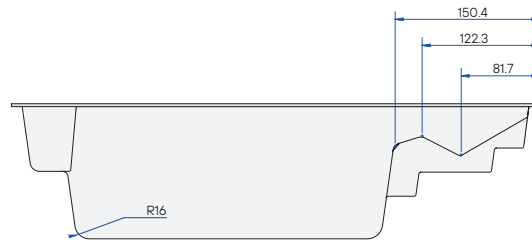
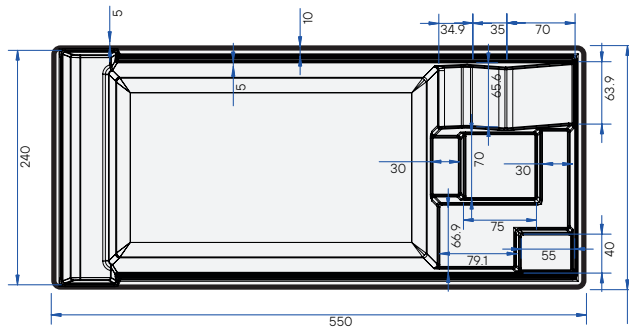

Vue View from inside the of the pool de

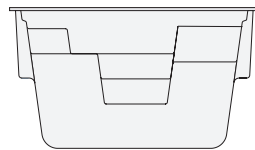

Digging sizes in cm – tolerance ± 2%

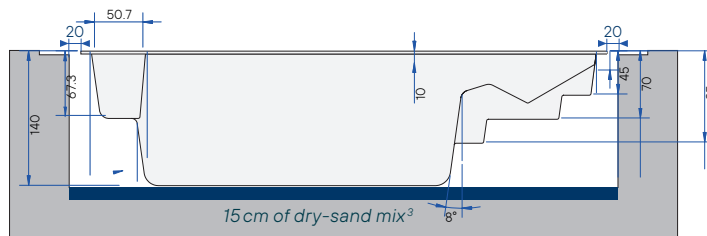

Vue View from inside the of the pool de

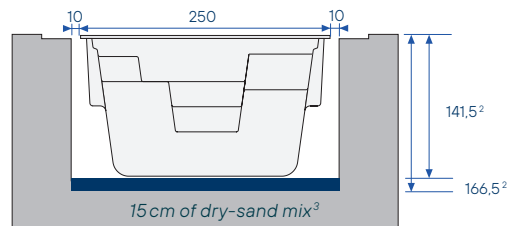

Note: the digging sizes do not take into account the necessary space for the coping stones.

¹ Needed for unloading & placing the pool. ² Depth taken from under the coping stone. ³ Mix of sand and cement, at a ratio of 250 kg per ton.

⁴ If combined with a counter current system, the position of inlets(s) may differ.